



EN Operating instructions.pages 1 to 4
Translation of the original operating instructions

Content

1 About this document

1.1 Function 1

1.2 Target group: authorised qualified personnel. 1

1.3 Explanation of the symbols used 1

1.4 Appropriate use 1

1.5 General safety instructions 1

1.6 Warning about misuse 1

1.7 Exclusion of liability 1

2 Product description

2.1 Ordering code 2

2.2 Special versions. 2

2.3 Destination and use 2

2.4 Technical data 2

3 Mounting

3.1 General mounting instructions 2

3.2 Dimensions 2

3.3 Mounting set-up 2

4 Electrical connection

4.1 General information for electrical connection. 3

4.2 Contact variants 3

5 Set-up and maintenance

5.1 Functional testing. 3

5.2 Maintenance 3

6 Disassembly and disposal

6.1 Disassembly. 3

6.2 Disposal 3

7 Appendix

7.1 EC Declaration of conformity 4

1. About this document

1.1 Function

This operating instructions manual provides all the information required for the mounting, set-up and commissioning to ensure the safe operation and disassembly of the safety switchgear. The operating instructions must be available in a legible condition and a complete version in the vicinity of the device.

1.2 Target group: authorised qualified personnel

All operations described in this operating instructions manual must be carried out by trained specialist personnel, authorised by the plant operator only.

Please make sure that you have read and understood these operating instructions and that you know all applicable legislations regarding occupational safety and accident prevention prior to installation and putting the component into operation.

The machine builder must carefully select the harmonised standards to be complied with as well as other technical specifications for the selection, mounting and integration of the components.

1.3 Explanation of the symbols used



Information, hint, note:

This symbol is used for identifying useful additional information.



Caution: Failure to comply with this warning notice could lead to failures or malfunctions.

Warning: Failure to comply with this warning notice could lead to physical injury and/or damage to the machine.

1.4 Appropriate use

The product must be exclusively used in accordance with the versions listed below or for the applications authorised by the manufacturer. Detailed information regarding the range of applications can be found in the chapter "Product description".

1.5 General safety instructions

The user must observe the safety instructions in this operating instructions manual, the country-specific installation standards as well as all prevailing safety regulations and accident prevention rules.



Further technical information can be found in the Schmersal catalogues or in the online catalogue on the Internet: www.schmersal.net.

The information contained in this operating instructions manual is provided without liability and is subject to technical modifications.

There are no residual risks, provided that the safety instructions as well as the instructions regarding mounting, commissioning, operation and maintenance are observed.

1.6 Warning about misuse



In case of inadequate or improper use or manipulations of the component, personal hazards or damage to machinery or plant components cannot be excluded.

1.7 Exclusion of liability

We shall accept no liability for damages and malfunctions resulting from defective mounting or failure to comply with this operating instructions manual. The manufacturer shall accept no liability for damages resulting from the use of unauthorised spare parts or accessories.

For safety reasons, invasive work on the device as well as arbitrary repairs, conversions and modifications to the device are strictly forbidden; the manufacturer shall accept no liability for damages resulting from such invasive work, arbitrary repairs, conversions and/or modifications to the device.

2. Product description

2.1 Ordering code

This operating instructions manual applies to the following types:

TQ 700-①

No.	Option	Description
①	11	1 NO/1 NC contact
	02	2 NC contacts
	20	2 NO contacts

2.2 Special versions

For special versions, which are not listed in the order code below 2.1, these specifications apply accordingly, provided that they correspond to the standard version.

2.3 Destination and use

Pull-wire switches are used on machinery and plants, where triggering the switching command must be enabled at arbitrary points on the wire run. If the tensioned pull-wire is pulled or in case of wire breakage, the switching function of the pull-wire switch is activated. (refer to image 1).

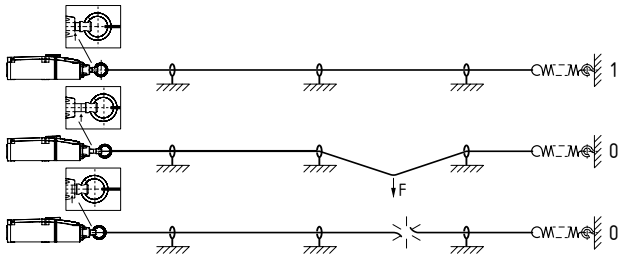

Image 1: position indication and actuation

Design/operating principle

The pull-wire switches are brought into the operational condition by the proper pre-tensioning of a maximum 10 m long wire. The inner switching element has 2 contacts; in a tensioned condition, the NC contacts are closed and the NO contacts are open.

The pull-wire switch does not meet the requirements of ISO 13850, IEC 60947-5-5 and NBR 13930.

2.4 Technical data

Standards:	IEC 60947-5-1
Enclosure:	thermoplastic
Cover:	thermoplastic
Protection class:	IP67 to IEC 60529
Contact material:	Silver
Switching system:	slow action with double break, NC contact with positive break ⊖
Connection:	screw terminals
Cable section:	max. 2.5 mm ² (incl. conductor ferrules)
Cable entry:	1 x M20 x 1.5
Rated impulse withstand voltage U_{imp} :	6 kV
Rated insulation voltage U_i :	500 V
Thermal test current I_{the} :	10 A
Rated operating current/voltage I_e/U_e :	4 A / 230 VAC, 4 A / 24 VDC
Utilisation category:	AC-15, DC-13
Required short-circuit current:	1000 A
Max. fuse rating:	6 A gG D-fuse (EN 60269-1)
Ambient temperature:	-25 °C ... +70 °C

Relative humidity:	30 ... 95%, no condensation, no icing
Wire length:	max. 10 m depending in relation to the range of ambient temperature (see image 3)
Mechanical life:	>1 million operations



AWG 14
Solid/Stranded
Max. torque: 7 in. lb.
Use copper conductors only.

3. Mounting

3.1 General mounting instructions

The installation may only be carried out by authorised personnel. The pull-wire switch is fitted by means of four screws (distance of the drill holes 30 mm or 60 mm).



The maximum perpendicular traction force to be exercised on the wire in order to activate the emergency pull-wire switch is 200 N, the maximum deflection is 400 mm.

3.2 Dimensions

All measurements in mm.

TQ 700

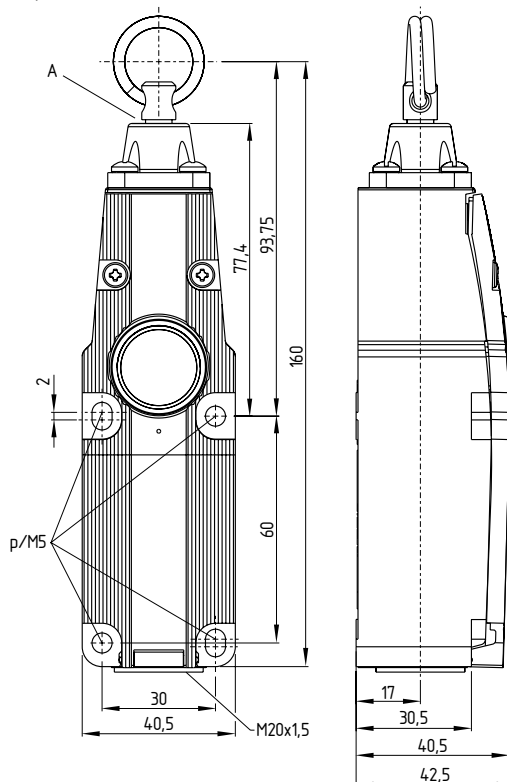

Key

A Position indication

3.3 Mounting set-up

For tensioned span lengths up to 10 m, intermediate wire supports are required every 2 to 5 m. To avoid resonance vibrations in the wire on machines with high vibrations, it is recommended to realise the individual support length differently. Assembly: refer to image 2.

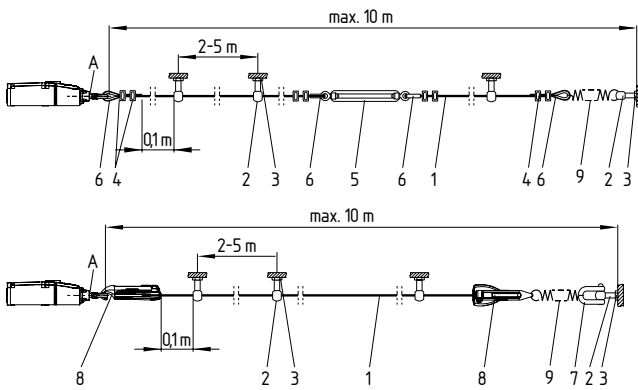

Image 2: mounting of the components

Key

- 1 Pull-wire with red PVC sheath Ø 5 mm (steel core: Ø 3 mm)
- 2 Eyebolt
- 3 Nut
- 4 Wire clamp
- 5 Tensioner
- 6 Wire thimble
- 7 Shackle
- 8 Wire tensioner S900
- A Position indication

The pull-wire must be fixed to the ring and then be pre-tensioned until the position indication is in the central position (refer to image 1).

Due to the thermal expansion behaviour of the wire, the maximum authorised wire length is determined by the ambient temperature range (refer to image 3).

We recommend the use of the ACC-700-RZ173 tension spring to reduce the effects of temperature variations.

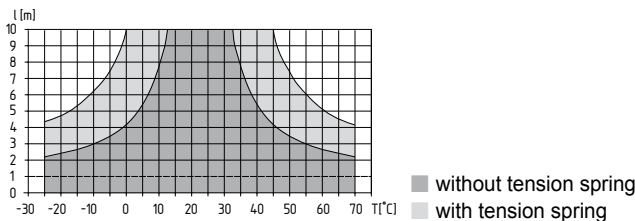

Image 3: temperature-dependent maximum wire length with or without tension spring

As the thimbles are subject to deformation in case of wire pull, the wire should be pulled several times after fitting. After that, the wire must be re-tensioned (see image 4).

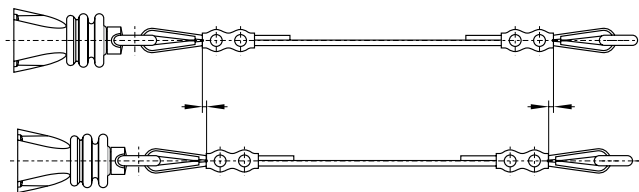

Image 4: deformation of the wire thimbles



In order to ensure an optimal operation safety and to save time during fitting, we recommend using the wire rope and the combined fixing and tensioning system from Schmersal. Alternatively, wire thimbles and wire clamps can be used in conjunction with a tensioner. In this case, the red PVC sheet must be removed in the clamp area prior to installing the wire rope.

4. Electrical connection

4.1 General information for electrical connection



The electrical connection may only be carried out by authorised personnel in a de-energised condition.

1. Cover screws must be loosened
2. Dust shield cap remove
3. Cable glands M20 x 1.5 with an appropriate degree of protection must be used
4. When wiring, please ensure that no cables are located within the range of the lever system and the pushbutton
5. The inside of the switch must be imperatively cleaned (e.g. removal of cable residues), considering that foreign bodies can affect the switching behaviour
6. The cover screws must be tightened uniformly (tightening torque 0.5 Nm)

The switch with plastic enclosure is double insulated. The use of an earth wire is not authorised.

Accessories cable gland:

- Ordering code: 103006013
- Authorised cable diameter: 6 - 12 mm
- Tightening torque: 4.5 Nm

4.2 Contact variants

The symbols are shown for the switch in non-actuated condition.

TQ 700-11

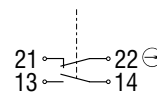

TQ 700-02

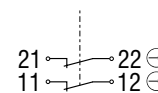

TQ 700-20

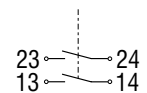

Key

- ⊖ Positive break NC contact

5. Set-up and maintenance

5.1 Functional testing

The function of the component must be tested. The following conditions must be previously checked and met:

1. Correct fixing of the pull-wire switch
2. Check the integrity of the cable entry and connections
3. Check the switch enclosure for damage
4. Check the functionality of the switch by actuating the wire
5. Check the cable tensioning by means of the position indicator

5.2 Maintenance

A regular visual inspection and functional test, including the following steps, is recommended:

1. Check the wire tension through the wire position indication and check the wire and the wire guides for damages and proper fitting
2. Check the functionality of the switch by actuating the wire
3. Check the cable entries and the wire connections
4. Remove particles of dust and soiling



Do not open the device when live.

Damaged or defective components must be replaced.

6. Disassembly and disposal



6.1 Disassembly

The switch must be disassembled in a de-energised condition only.

6.2 Disposal

The switch must be disposed of in an appropriate manner in accordance with the national prescriptions and legislations.

7.1 EC Declaration of conformity

EC Declaration of conformity		
Translation of the original Declaration of Conformity		ACE Schmersal Eletroeletrônica Industrial Ltda. Av. Brasil, nº 815 Vila Esplanada CEP: 18550-000 Boituva – SP Brazil Internet: www.schmersal.com.br
We hereby certify that the hereafter described products both in their basic design and construction conform to the applicable European Directives.		
Name of the component:		TQ 700
Description of the component:		Pull-wire switches
Harmonised EC-Directives:		2006/95/EG EC Low Voltage Directive
Place and date of issue:		Boituva, November 24, 2015
		
		Authorised signature Marco Antonio De Dato Head of Engineering and Design

TQ700-E-EN



K.A. Schmersal GmbH & Co. KG
Mödinghofe 30, D - 42279 Wuppertal
Postfach 24 02 63, D - 42232 Wuppertal

Phone +49 - (0)2 02 - 64 74 - 0
Telefax: +49 - (0)2 02 - 64 74 - 1 00
E-Mail: info@schmersal.com
Internet: http://www.schmersal.com

Production site:
ACE Schmersal
Eletroeletrônica Industrial Ltda.
Av. Brasil, nº 815
Jardim Esplanada – CEP: 18550-000, Boituva – SP
Brazil
Phone +55 - (0)15 - 32 63 - 9866
Fax +55 - (0)15 - 32 63 - 9890
E-Mail: vendas@schmersal.com.br
Internet: http://www.schmersal.com.br